

Thermoelectric Cooler Performance Specifications

TES1-031012-8.8X8.8 W70mm

Hot Side Temperature(°C)	27 °C	50 °C
Qmax (Watts)	2.51	2.81
Delta Tmax(°C)	66	72
I _{max} (Amps)	1.2	1.2
V _{max} (Volts)	3.7	4.0
Module Resistance(Ohms)	2.64	2.98

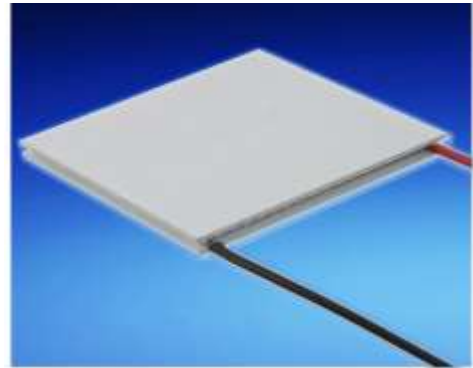

**Tolerances for thermal and electrical parameters ± 10%.

Performance Curves Th=27°C

Performance Curves Th=50°C

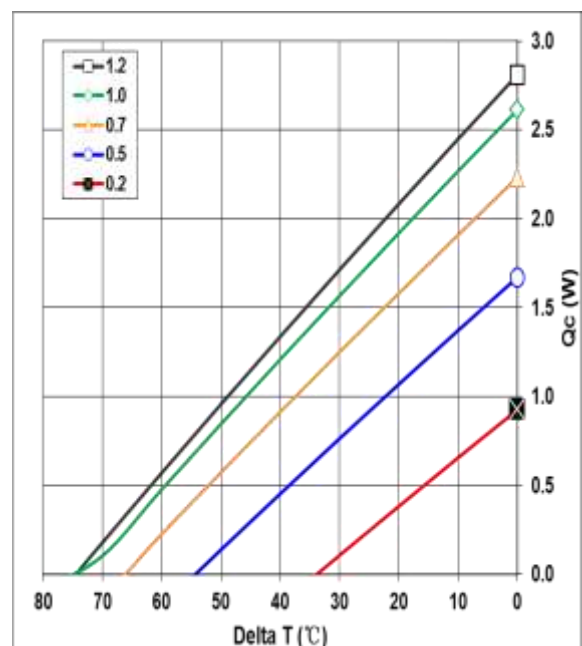
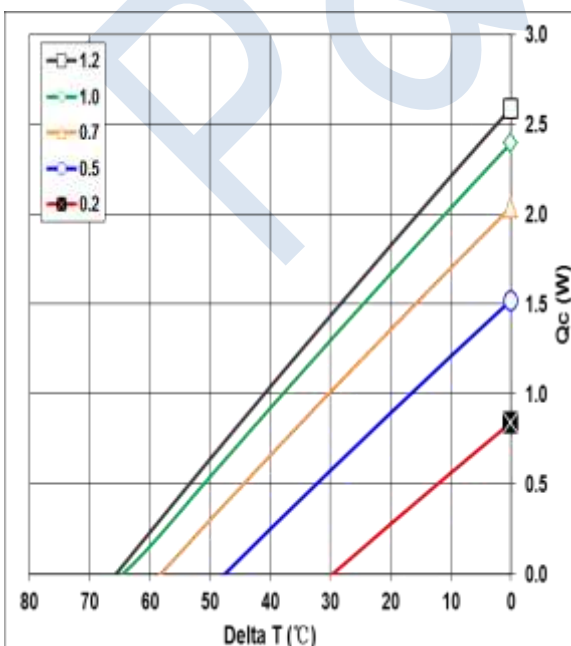
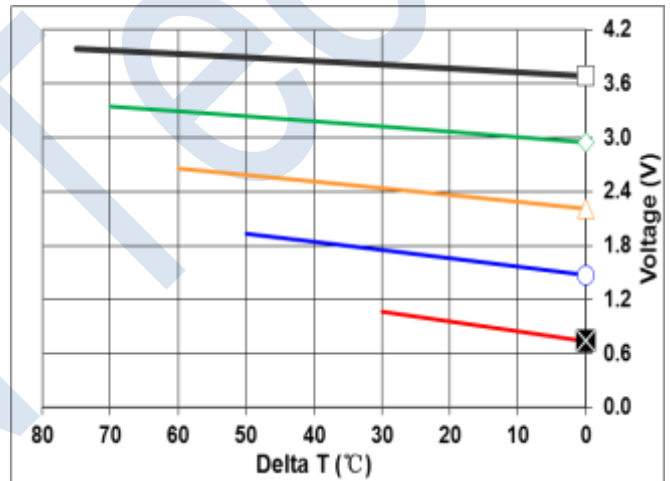
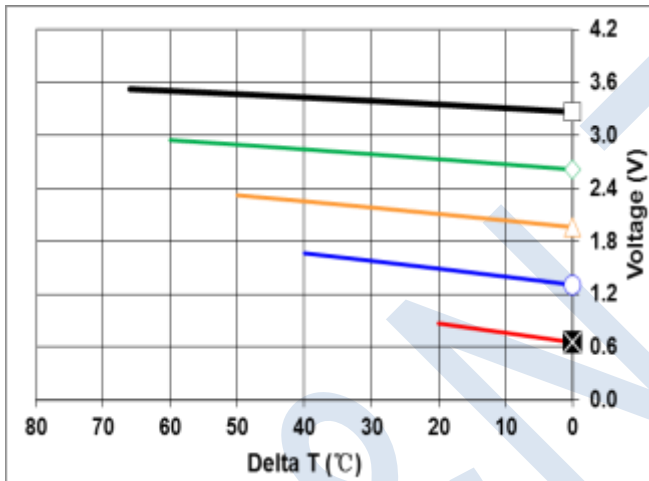

Mechanical Drawing:

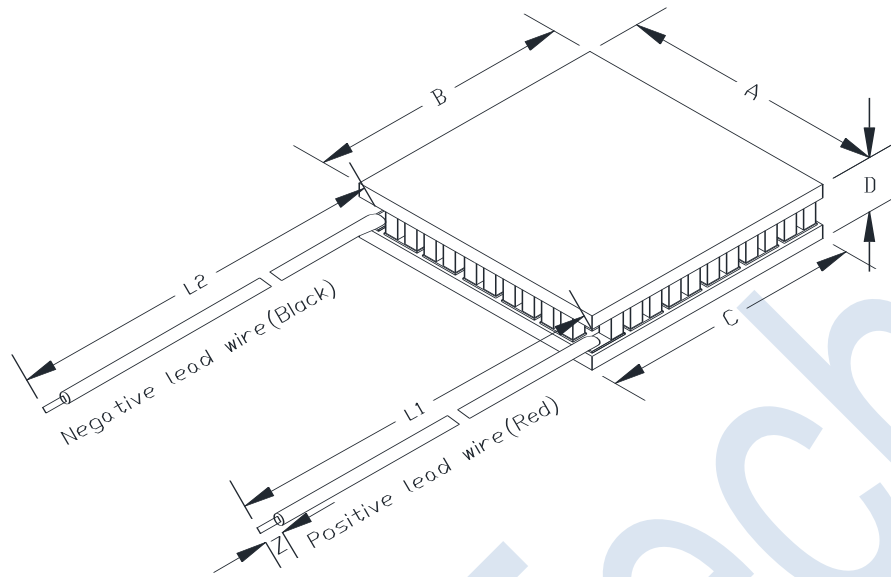

D(mm)	2.7 ± 0.02	Wires	PVC 32 AWG
A(mm)	8.8 ± 0.2	Wire length(mm)L1/L2	70 ± 5
B(mm)	8.8 ± 0.2	Z(mm)	5 ± 2
C(mm)	8.8 ± 0.2	Sealing	-
Flatness/Parallelism(mm)	0.05/0.05	Solder T(melting) (°C)	138

Operation Tips:

- Max Operating Temperature: **90°C**.
- Do not exceed I_{max} or V_{max} when operating module.
- Please consult P&N Technology for moisture and corrosion protection options.

Address: 5/F Xinfei Building 28th Xiangming Road, Torch (xiang'an) Hi-tech Zone, Xiamen Fujian China.

Sales Tel: + 86 - 592 - 352 1988

Fax: +86-592-352 1989

Postcode: 361 101

Web: www.pengnantech.com